



Quick
Installation
Guide

DVR

The first time you run the DVR, you will be required to set your password immediately in order to protect your privacy.

Please be sure to record your username and password and save them in a secure place. If you forget your password, you will be unable to login the system, please contact your reseller to reset the password.

1 Connection Diagram

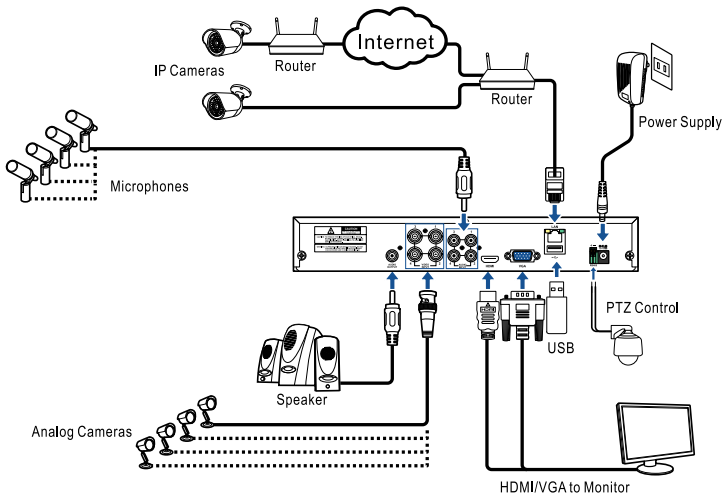

2 HDD Installation

Caution: DO NOT install or remove the hard disk drive while the device power is turned ON.

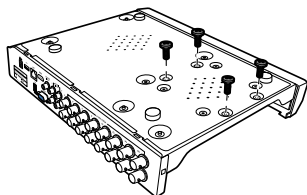
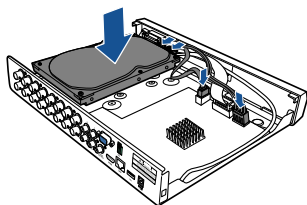
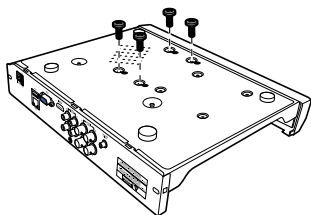
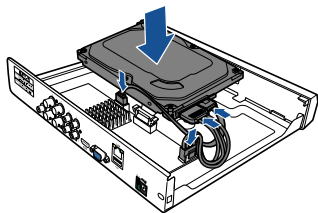

- a) Connect the data and power cables to the HDD and place the HDD on the DVR case.
- b) Carefully flip the DVR case and secure the HDD to the DVR with the screws.

Note: Depending on the model you purchased, the actual product may be slightly different from the images above.

3 Startup Wizard

Wizard setting menu includes: start wizard page, Network, Network Configuration, Date/Time, IPC Setup, Disk, Resolution, Mobile and Summary.

1) Start wizard

Click the **Start Wizard** to proceed to the next step



2) Network Configuration

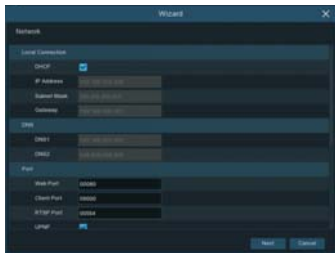

If you connect to a router allows to use DHCP, please check the **DHCP** box. The router will assign automatically all the network parameters for your DVR. Unless the network is manually addressed below parameters:

IP Address: The IP address identifies the DVR in the network. It consists of four groups of numbers between 0 to 255, separated by periods. For example, "192.168.001.100".

Subnet Mask: Subnet mask is a network parameter which defines a range of IP addresses that can be used in a network. If IP address is like a street where you live then subnet mask is like a neighborhood. The subnet address also consists of four groups of numbers, separated by periods. For example, "255.255.000.000".

Gateway: This address allows the DVR to access the Internet. The format of the **Gateway** address is the same as the **IP Address**. For example, "192.168.001.001".

DNS1/DNS2: DNS1 is the primary DNS server and DNS2 is a backup DNS server. Usually should be enough just to enter the DNS1 server address.

Port

Web Port: This is the port that you will use to log in remotely to the DVR (e.g. using the Web Client). If the default port 80 is already taken by other applications, please change it.

Client Port: This is the port that the DVR will use to send information through (e.g. using the mobile app). If the default port 9000 is already taken by other applications, please change it.

RTSP Port: This is the port that the DVR will be allowed to transmit real-time streaming to other device (e.g. using a streaming Media player.).

UPnP: If you want to log in remotely to the DVR using Web Client, you need to complete the port forwarding in your router. Enable this option if your router supports the UPnP. In this case, you do not need to configure manually port forwarding on your router. If your router does not support UPnP, make sure the port forwarding is completed manually in your router.

PPPoE

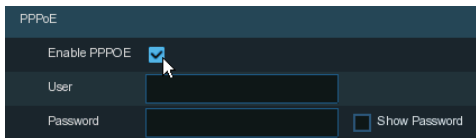

PPPoE	
Enable PPPOE	<input checked="" type="checkbox"/>
User	<input type="text"/>
Password	<input type="password"/> <input type="checkbox"/> Show Password

This is an advanced protocol that allows the DVR to connect to the network more directly via DSL modem.

Check the "Enable PPPOE" box, and then enter the User name & Password of the PPPoE.

3G

This is a prior using the mobile network, you need to connect a 3G dongle to the DVR.

Enable the 3G option, enter the APN, Dial Code, User name & password according to the instruction of your 3G dongle device.

3) Date/Time

This menu allows you to configure the Date, Time, Date Format, Time Format, Time Zone, NTP and DST.

Date and Time

Click on the calendar icon to set the current system date.



Date and Time	NTP	DST
Date		
Time		
Date Format		
Time Format		
Time Zone		

Date: Click on the calendar icon to set the system date.

Time: Click to set the system time.

Date Format: Choose from the dropdown menu to set preferred date format.

Time Format: Choose time format between 24Hour and 12Hour.

Time Zone: Set the correct time zone.

NTP

NTP stands for Network Time Protocol. This feature allows you to synchronize the date and time automatically on the DVR over Internet. Therefore, the DVR needs to be connected to the Internet.

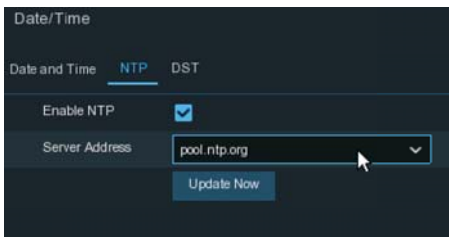

Check the “NTP” box, and select the NTP server.

DST

DST stands for Daylight Savings Time.



DST: Enable if Daylight Saving Time (DST) is observed in your region

Time Offset: Select the amount of time to offset for DST

Time Mode: Choose to set the daylight saving time in weeks or in days

Start Time/End Time: Set the start time and end time for daylight saving

4) IP Camera

This menu allows you to add IP cameras to the DVR.

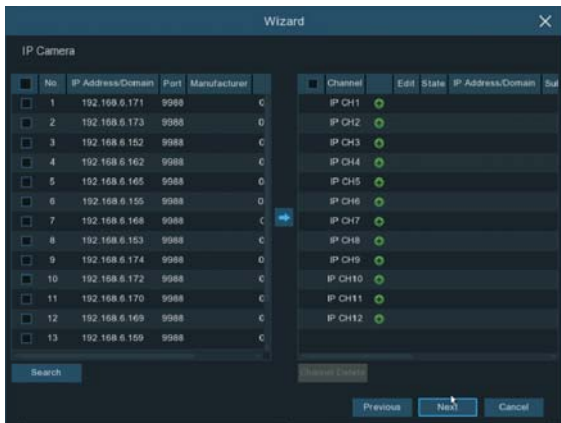

Click **Search** to search IP cameras in the same network. Choose the IP camera(s) you want to add, and then click ➔ icon to add to the DVR.

Position: Left-Top

Port: 9988 Auto

Protocol: Private Auto

User Name: admin

Password: Show Password

Add Cancel

Enter the camera's user name & password to add the camera(s).

You can also click ⊕ button to add individual IP camera to a single channel.

Add IP Camera ✕

No.	IP Address/Domain	Port	Manufacturer	Device Type	MAC Address	Software Version
1	192.168.1.151	9988	Raysharp	IP Camera	B7-91-06-21-09-1F	
2	192.168.1.152	9988	Raysharp	IP Camera	02-18-09-3B-A7-BB	
3	192.168.1.153	9988	Raysharp	IP Camera	E1-A1-66-94-46-B9	
4	192.168.1.154	9988	Raysharp	IP Camera	CF-C1-11-5A-CA-7A	
5	192.168.1.155	9988	Raysharp	IP Camera	B3-5B-52-54-0B-1D	
6	192.168.1.156	9988	Raysharp	IP Camera	6B-EC-57-ED-06-19	
7	192.168.1.157	9988	Raysharp	IP Camera	74-E4-95-CE-40-D3	
8	192.168.1.158	9988	Raysharp	IP Camera	ED-56-51-B3-8E-58	
9	192.168.1.159	9988	Raysharp	IP Camera	63-7A-76-1A-58-95	
10	192.168.1.160	9988	Raysharp	IP Camera	05-DA-0A-16-EA-CA	

IP Address/Domain:

Alias:

Position: ▼

Port:

Protocol: ▼

User Name:

Password: Show Password

Bind channel: ▼

Search
Add
Cancel

Click **Search** button to search IP cameras, and then click one of the IP camera in the device list.

IP Address/Domain: IP address or domain name of the IP camera

Alias: Name of the IP camera

Position: Position to display the camera name on the screen.

Port: Port of the IP camera

Protocol: Choose the protocol of the IP camera from the dropdown menu

User Name: User Name of the IP camera

Password: Password of the IP camera

Bind channel: Choose a channel of the DVR you want to attach to

5) Disk

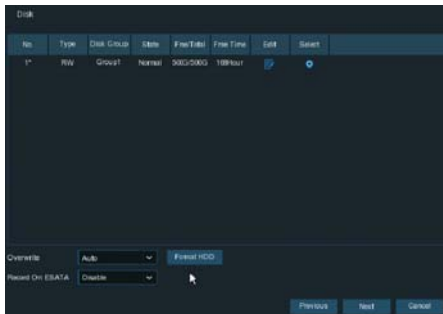

If the HDD is installed in the DVR for the first time, it must be formatted. Select the HDD and then click **Format HDD** button to format the HDD.

Overwrite: Use this option to overwrite the old recordings on the HDD when the HDD is full. For example, if you choose the option 7 days then only the last 7 days recordings are kept on the HDD. To prevent overwriting any old recordings, select Disable. If you have disabled this function, please check the HDD status regularly, to make sure the HDD is not full.

Record On ESATA: If your DVR comes with an e-SATA port on the rear panel, you can enable to record the video to e-SATA HDD.

6) Resolution

Choose an output resolution matches to your monitor. The DVR supports to adjust the output resolution automatically to match the best resolution of your monitor when the system is starting up.

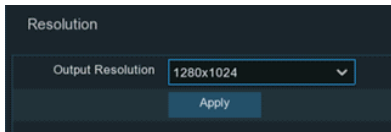

7) Mobile

If your DVR come with a P2P ID, you can scan the QR code with your mobile app to view the DVR remotely.

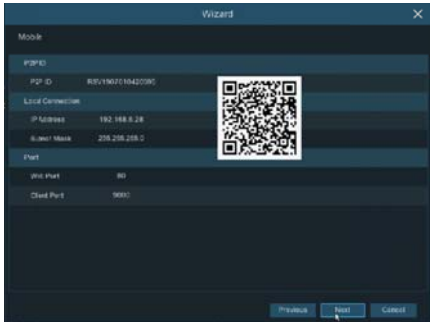

8) Summary

You can check the system summary information you had set in the start wizard and finish the wizard.

Tick "**Don't show this window next time**" if you don't want to display Start Wizard when system reboot next time. Click **Finish** button to save & exit.

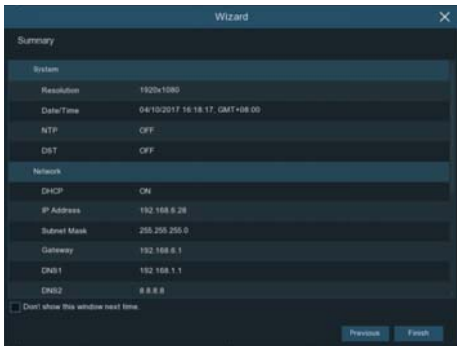

Live View Screen Overview

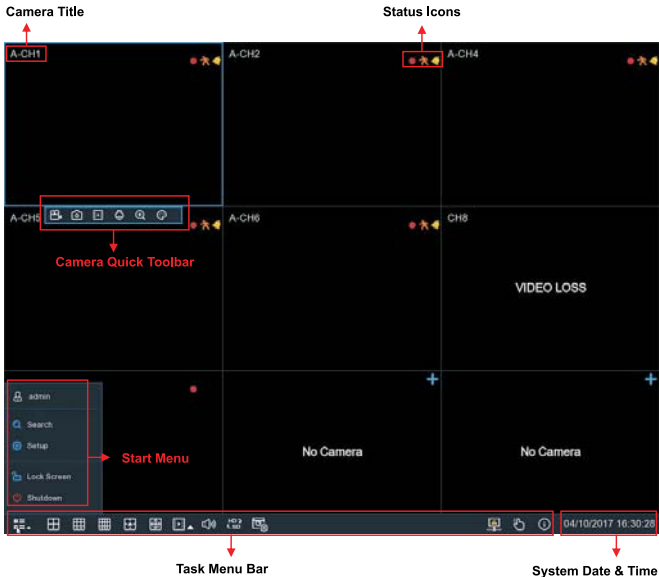

Camera Title

To display the camera title







A-: This indicates that the camera connected is an AHD camera

T-: This indicates that the camera connected is a TVI camera

C-: This indicates that the camera connected is a CVI camera

IP: This indicates that the camera connected is an IP camera

Status Icons

-  This indicates that the DVR is currently recording.
-  This icon appears when the camera has detected motion.
-  The icon indicates that the external I/O alarm device is triggered
-  This icon indicates that the HDD is in error to work
-  This icon indicates the HDD is unformatted
-  This icon indicates the HDD is full.
-  This icon indicates the HDD is read-only.

VIDEO LOSS: The analog camera is disconnected.

No Camera: IP camera is disconnected.

Decoding Failed: The DVR doesn't support this kind of IP camera compression standard, please change to H.264 compression standard.

Click to open **Quick Add** menu to add IP camera

Click to edit current IP camera

4 Remote Access via Web Client

Use the Web Client to remotely access your DVR at anytime via a PC. Before you access the Web Client, you need to ensure that the network settings of the DVR are configured properly. The most convenient and easiest way is if you have set the DVR a static IP address . It means you only need to open the web browser on your PC and type in the static IP address you have set on the DVR. However, if the IP address of the DVR is assigned by a DHCP server , then it means that each time you reboot the DVR, the IP address changes. In this case, ask if your ISP can provide you a static IP address. If not, then configure the DDNS service. Also, please make sure the UPnP is configured in the DVR and router, or the manual port forwarding is completed in the router.

You will need to install the plug-in if this is the first time you connect to your DVR via IE, Google Chrome, Firefox, or Mac Safari.

Login to Web Client

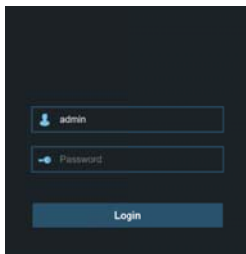
A screenshot of a web client login interface. It features a dark background with three light blue input fields and a button. The first field is labeled 'admin' with a user icon, the second is labeled 'Password' with a key icon, and the third is a 'Login' button.

admin

Password



Login

Notice for Windows 8 and Windows10 Users:

- 1) If you are running Windows 8 or Windows10,you will have to right click on Internet Explorer from the start menu and select "Run as administrator".
- 2) After successful Login to the Net Viewer,the system will enter into live display interface and connect to audio/video feed automatically.



5 Remote Live View on Mobile Devices

1. Open the App Store (iOS) or Play Store (Android).
2. Search for and install RXCamView application.
3. Open RXCamView application ()
4. Go to Device. Click '  ' to add new device. Scan QR code under DVR box. Then input client port, user name and password, and then click "Save" to log into the DVR.
5. Live View

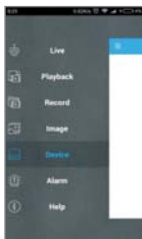

4



5



MEMO



www.hilocctv.com